

OPERATING INSTRUCTIONS

操作說明書

Ventilating Fan 排氣扇

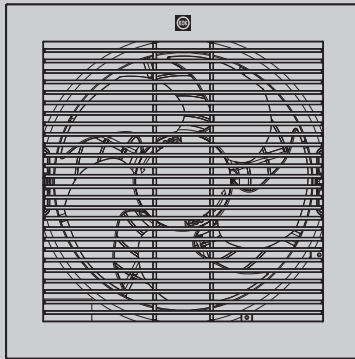

Model 型號 **20TGQF**

Please read these instructions carefully before attempting to install, operate or service the Ventilating Fan. Failure to comply with instructions could result injury and / or property damage. In that case the product shall not warrant them. Please retain this booklet for future reference.



安裝、使用和維護換氣扇前，請仔細閱 讀本說明書。不遵照此說明書進行操作有可能導致人員受傷和/或財產損失，如果發生以上情況，生產廠家將不對其負責任，請妥善保管好此說明書以備日後參考。

SAFETY INSTRUCTIONS

安全指引

Please observe strictly



请务必遵守

- Disconnect the power supply until blade is stationary before cleaning and maintenance.
在清潔和維護前，請確保換氣扇的電源已經關閉且扇葉停止轉動。
 
- This appliance is not intended for use by persons (including children) with reduced physical, sensory or mental capabilities, or lack of experience and knowledge, unless they have been given supervision or instruction concerning use of the appliance by a person responsible for their safety. Children should be supervised to ensure that they do not play with the appliance.
本設備不適合身體、感官或精神能力下降，或缺乏經驗和知識的人員（包括兒童）使用，除非負責其安全的人員對其使用設備進行了監督或指導。應監督兒童確保其不玩耍本設備。
- If the supply cord is damaged, it must be replaced by the manufacturer or its service agent or a similarly qualified person in order to avoid a hazard.
如果電源軟線損壞，為避免危險，必須由製造廠商，其維修部或類似的專業人員更換。





The following explanations must always be observed in order to prevent harm to users or other people and prevent damage to property.

為了避免給您及其它人造成傷害，這裡我們列出了以下安全注意事項，請務必遵守，各種標誌的含義請參照以下內容。





- The following displays are classified and explained to what extent harm or damage occurs when the display details are ignored and the unit in question is wrongly used.
無視或錯誤理解這些標誌，會產生下列兩種情況。

	Warning 警告	This indication means : Must be treated seriously that this may result in death or serious injury. 本標誌所表示的內容為“可能造成人員重傷或傷亡”。
	Caution 注意	This indication means: Must be treated seriously that this may result in injury or physical damage. 本標誌所表示的內容為“可能造成人身傷害和其它物品損害”。

- The types of details to be observed are classified and explained in the following illustrated display. (Below are the series of illustrated displays)
需要遵守的詳情類型進行了分類，並在以下插圖顯示中進行了說明。（以下為插圖顯示系列）

		This type of pictorial symbol indicates a “Prohibited” action that must be avoided. 此標誌表示為禁止事項
		This type of pictorial symbol indicates a “Compulsory” action that must be performed. 此標誌表示強制事項

Warning 警告

- Before connecting the power supply, connect the earth grounding wire first.
接駁電源線前，請先將地線接受。
 
- Do not disassemble the unit for reconstruction. It may cause fire or electric shock. Repairing should be serviced by authorized service center.
禁止拆開本產品進行改造。否則可能導致火災或觸電。
修理時必須到指定的維修店進行修理。

- Use this fan at the rated voltage and frequency indicated on the name plate.
須根據已標明的額定電壓及頻率使用這抽氣扇。
 May cause fire or shorten the life of motor. 220-240 V 50 Hz 

INSTALLATION CAUTIONS

安裝注意事項



Caution
注意

- Do not install this fan where it could be directly exposed to water or excess vapour.

不要把抽氣扇安裝在容易被水噴到或煙霧，水氣過多的地方。

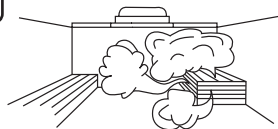

- Never install this fan over cooking equipment.

不要把抽氣扇裝在烹調設備上。

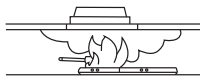

- Install this fan in the ceiling only.

只可把這抽氣扇安裝在天花板。

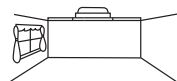

- Do not connect air duct to the fan keep the air outlet clear.

請勿將風喉接到此抽氣扇，應保持抽氣扇出風口暢通無阻。



- Be sure to provide an appropriate ventilation opening.

必需安裝在通風口的位置上。

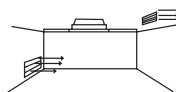

- This ventilating fan should be mounted above 2.3m from the floor.

此換氣扇的安裝高度，距離地面必須大於2.3m。



- Product must be install on to the ceiling which is enough strong, if the ceiling is not enough strong it must be reinforced for it to be strong enough.

產品必須安裝在足夠牢固的天花板上，如果天花板不夠牢固，必須對其進行加固。



- This fan should be installed so that the metal parts of the product and mounting screw do not contact any metallic members in the wall, such as metal laths, wire laths and metal plate, it is possible to cause fire hazards in case of leak.

本產品在安裝時，安裝螺釘等金屬部件禁止借助于天花板中的金屬條，線槽或金屬板等金屬部件材料進行接地，以防止發生漏電現象而導致火災。



- Use a device for disconnection from the supply, having a contact separation of at least 3mm in all poles in accordance with wiring rule.

在安裝時，需在供電線路中安裝其觸點間距不小於3mm的雙極斷開裝置，必須按照當地的電氣配線的規定進行連接。



- This fan must be installed by a qualified technician Otherwise, it is possible to be dropped down.

此換氣扇必須由有資格的专业人員進行安裝。否則可能會導致產品脫落而發生危險。



HOW TO INSTALL

裝配方法

DIMENSIONS / 尺寸

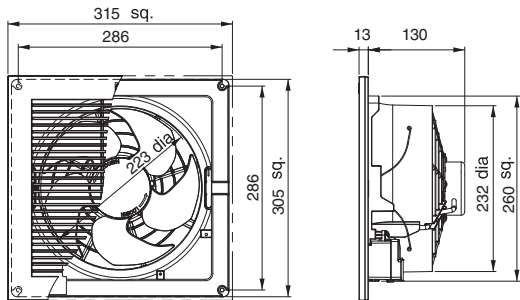

WIRING DIAGRAM

電器接駁原理圖

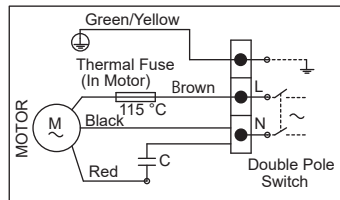

OPERATION / 操作方法

Switch 開關掣	Connect the power cord to the ON/OFF switch and install the switch on the wall. 將電源接駁到安裝在牆上的開關掣。	Stop 停止 	Exhaust 排氣
----------------------	--	-----------------------	--------------------------

SUPPLIED ACCESSORIES / 包裝附件清單

No.	序號	Appearance 圖樣	Name	名稱	Quantity 數量
①			Mounting screws	安裝螺絲	4
②			Louver	通氣窗	1
③			Operating instructions	操作說明書	1

HOW TO INSTALL

裝配方法

Open the wiring cover and take off the cord clip.

打開接線蓋，取下電線夾

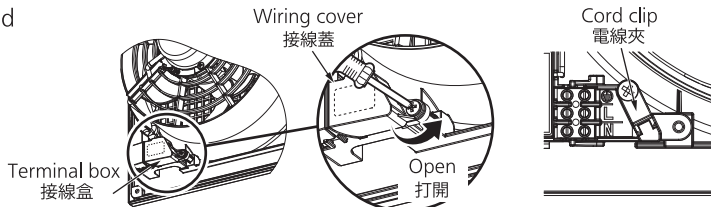

Connect the power cord according to the wiring diagram.

It must be connected with earth wire.(15-20mm longer than other lead wires.)

Replace the cord clip and the wiring cover .Secure with the cord clip and screw provided.

按照接線圖連接電源線。

必須連接地線。(比其他導線長15 - 20mm)

恢復電線夾和接線蓋，並用螺絲加固。

Note : In order to avoid the dangers, it must be connected by qualified technician.

注意：為了避免發生意外，此安裝必須由專業人員完成。

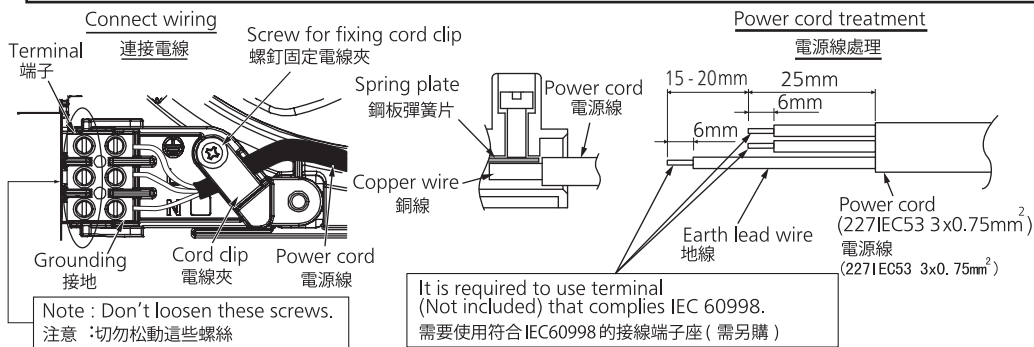

Note : Don't loosen these screws.
注意：切勿鬆動這些螺絲

It is required to use terminal (Not included) that complies IEC 60998.
需要使用符合IEC60998的接線端子座 (需另購)

- Make sure all connections are fastened firmly after wiring is finished.
完成接線後請確保所有連接都已牢固地固定。
- The all connections should be accommodated in a suitable compartment.
所有連接應安裝在合適的隔間內。
- Use a device for disconnection from the supply, which having a contact separation of at least 3mm in all poles (switch), which must be incorporated in the fixed wiring in accordance with the local electrical wiring rules.
在安裝時，必須按照當地電氣配線的規定，在固定配線線路中安裝其觸電開距不小于 3mm的全極斷開裝置
- Electrical wiring must be done according to the wiring diagram and local electrical wiring rules for fixed wiring.
固定接線必須按接線圖和當地接線規則進行接線。
- Do not kink or pinch the supply wiring.
Otherwise, it may cause electric leakage, electric shock or fire.
不要扭結或擠壓電源線。
否則，可能會導致漏電、觸電或火災。

HOW TO INSTALL

裝配方法

1. Fix a wooden frame to the ceiling where the fan is installed.
2. The wooden frame should form a 270mm square opening.
3. Fix the frame at minimum distance 250mm from the ceiling and 100mm from the wall on any side.
4. Install the fan body on the wooden frame by mounting screws.
5. Secure the blade assembly and spinner to the motor.
6. Connect the power cord to the power supply.
7. Squeeze and insert the springs into the spring locking holes.

1. 將木框安裝在天花板以上。
2. 木框內尺寸應為 270mm 的正方形。
3. 木框應安裝在距離屋頂最少 250毫米及距離牆身最少100毫米的位置。
4. 用螺絲將扇身安裝在木框。
5. 將扇葉及旋鈕牢固地安裝在馬達。
6. 將抽氣扇的電源線接駁妥當。
7. 將通氣窗彈弓擠入抽氣扇身的彈弓插槽。

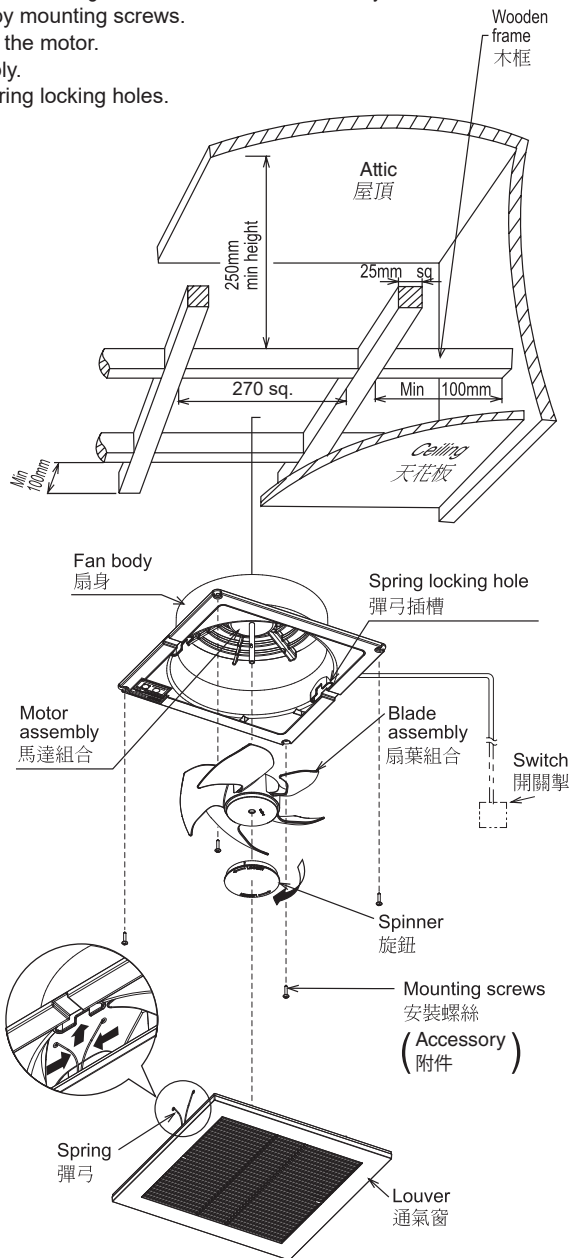

MAINTENANCE PRECAUTIONS

維護注意事項



Caution
注意

- First, ensure that the fan is switched off.

首先、確保抽氣扇的電源是被關掉的。

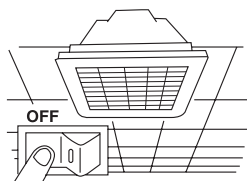

- Never use petrol, benzene, thinner or any other such chemicals for cleaning the ventilating fan.

千萬不要用汽油、苯、溶劑或任何類似的化學藥物清洗這抽氣扇。



- Do not allow water to contact electrical part such as motors or switches.

電動馬達或開關制等電器元件絕對不能被水接觸。

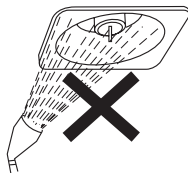

- Do not immerse blade or other resin parts in hot water over 60°C.

風扇葉等塑料零件不能用高於60°C的熱水浸洗。

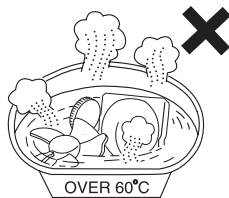

- When the product is to no longer be used, it must not be left in place but removed to prevent it from possibly dropping.

為了避免在萬一的情況下產品掉落，長期不使用本產品時，不得放置不管，而應予以拆除。



- Wear plastic gloves during cleaning may avoid accidents.

為避免意外發生，清潔時請帶上膠手套



SPECIFICATIONS

規格

Model 型號	Air direction 氣流方向	Voltage 電壓 [V]	Frequency 頻率 [Hz]	Power consumption 耗電量 [W]	Air Volume 排氣量 [CMH]	Weight 重量 [kg]
20TGQF	EX.	220	50	18	520	1.30
		230		19	525	
		240		20	530	

* Insulation class E,
Type of Insulation: Functional Insulation

* E級絕緣
絕緣種類：機能絕緣

Rating

額定電壓及頻率

[20TGQF : AC 220-240 V 50 Hz]

KDK Company, Division of PES

Head office: 4017, Takaki-cho, Kasugai, Aichi, Japan

20TGQF461